

EE 330

Lecture 25

- Small Signal Analysis
- Small Signal Models for MOSFET and BJT

Fall 2023 Exam Schedule

Exam 1	Friday Sept 22	
Exam 2	Friday Oct 20	
Exam 3	Friday Nov. 17	
Final	Monday Dec 11	12:00 – 2:00 p.m.

Small-Signal Analysis

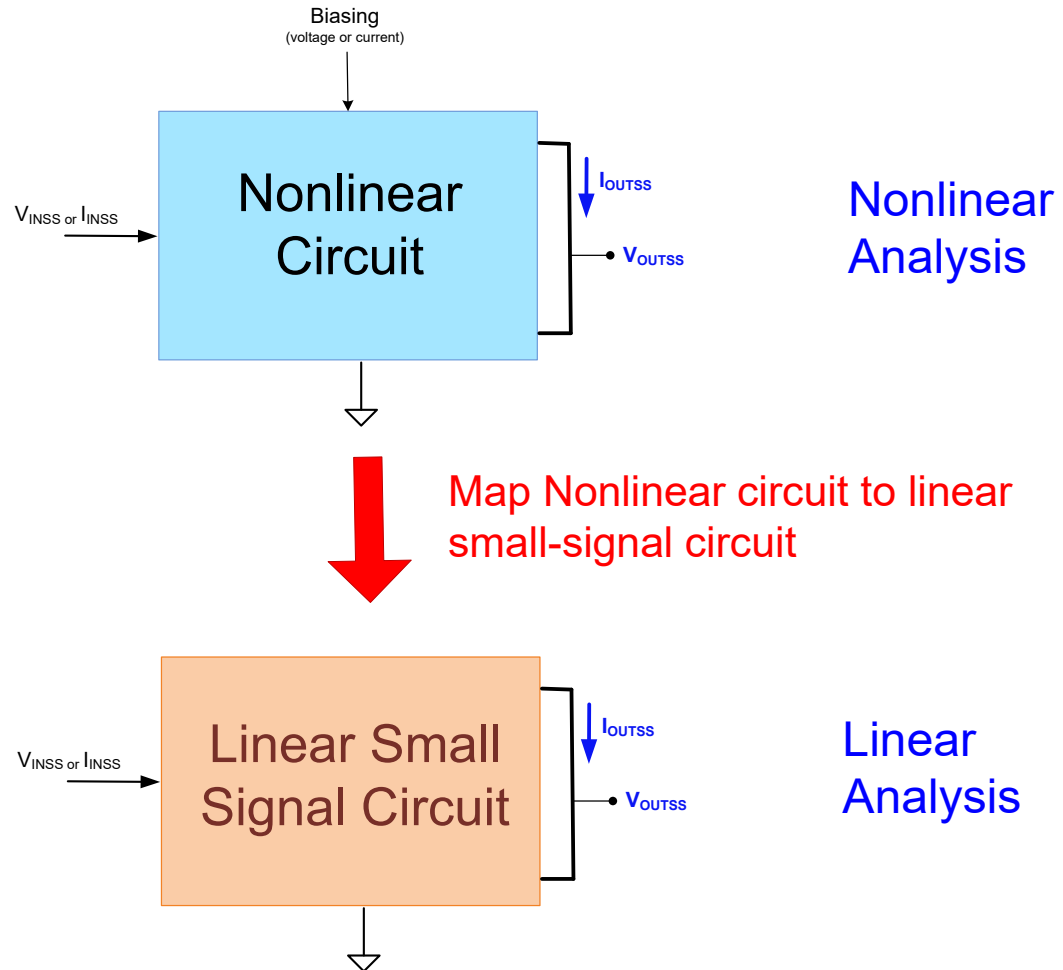

- Will commit next several lectures to developing this approach
- Analysis will be MUCH simpler, faster, and provide significantly more insight
- Applicable to many fields of engineering

“Alternative” Approach to small-signal analysis of nonlinear networks

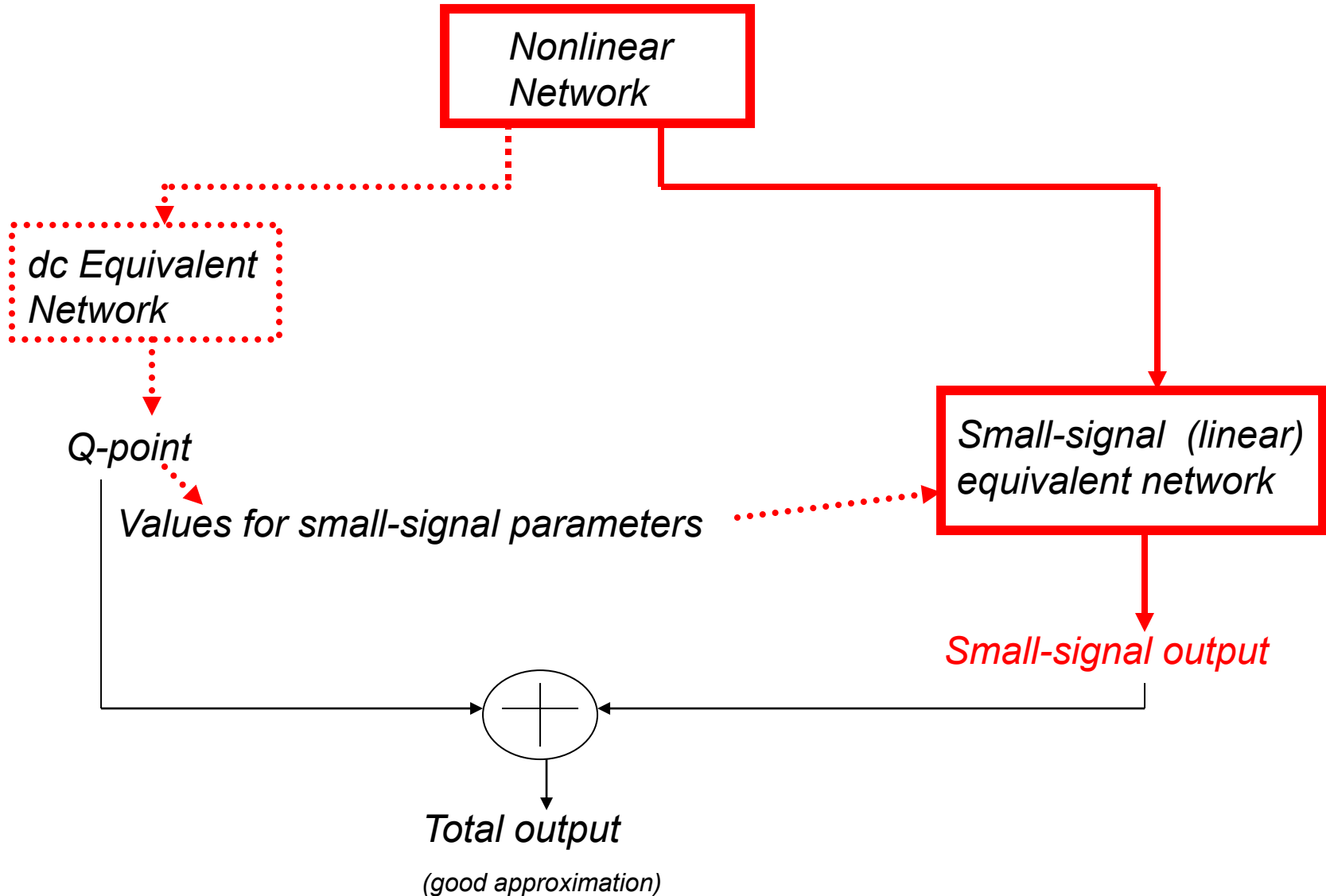



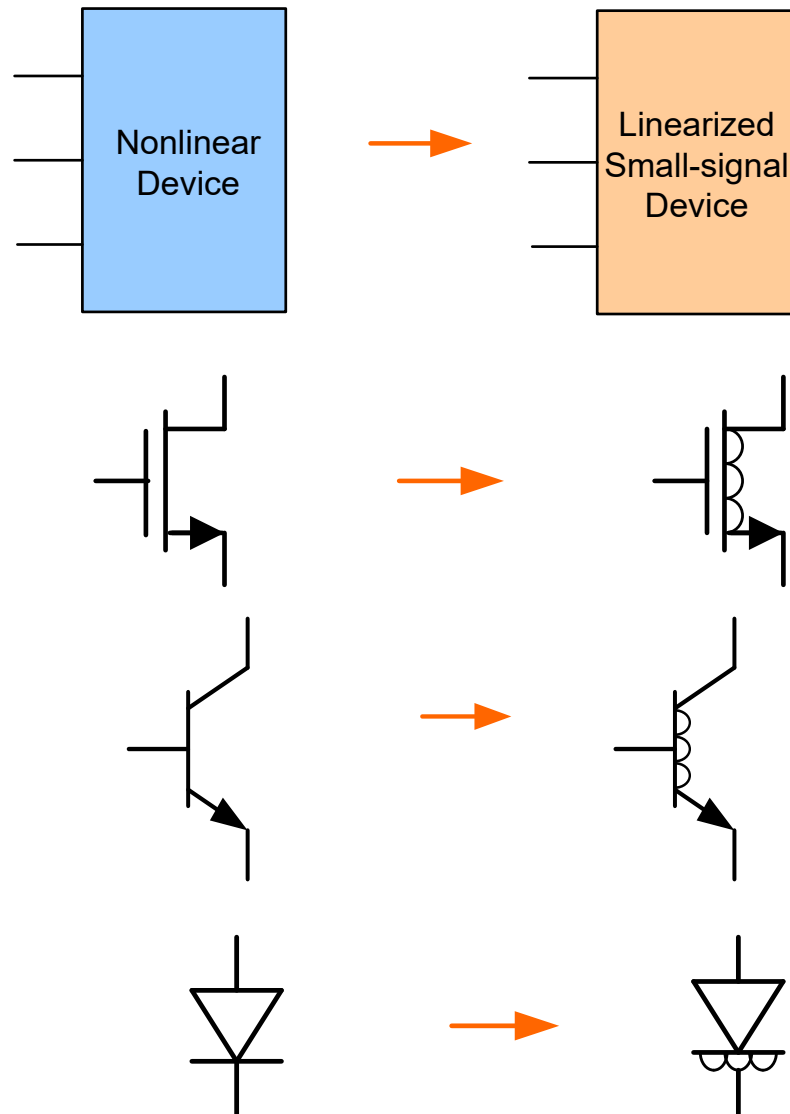









Linearized nonlinear devices









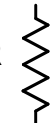
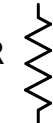



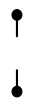

This terminology will be used in THIS course to emphasize difference between nonlinear model and linearized small signal model

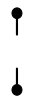
Review from Last Lecture

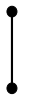
Small-signal and simplified dc equivalent elements

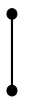



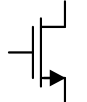
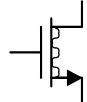
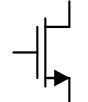
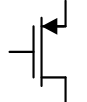
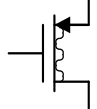
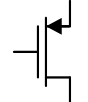

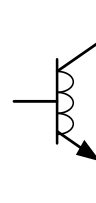
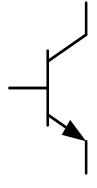

	Element	ss equivalent	Simplified dc equivalent
dc Voltage Source	V_{DC} 		V_{DC} 
ac Voltage Source	V_{AC} 	V_{AC} 	
dc Current Source	I_{DC} 		I_{DC} 
ac Current Source	I_{AC} 	I_{AC} 	
Resistor	R 	R 	R 

Small-signal and simplified dc equivalent elements

	Element	ss equivalent	Simplified dc equivalent
Capacitors	<p>C</p>  <p>Large</p>		
	<p>C</p>  <p>Small</p>	<p>C</p> 	
Inductors	<p>L</p>  <p>Large</p>		
	<p>L</p>  <p>Small</p>	<p>L</p> 	
Diodes			 <p>Simplified</p>
MOS transistors (MOSFET (enhancement or depletion), JFET)			 <p>Simplified</p>
			 <p>Simplified</p>

Review from Last Lecture

Small-signal and simplified dc equivalent elements

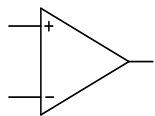
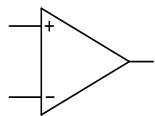
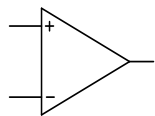
	Element	ss equivalent	Simplified dc equivalent
Bipolar Transistors			 Simplified
			 Simplified
Dependent Sources (Linear)			
	$V_O = A_V V_{IN}$ $I_O = A_I I_{IN}$ $V_O = R_T I_{IN}$ $I_O = G_T V_{IN}$		
			

Small-Signal Model of 4-Terminal Network

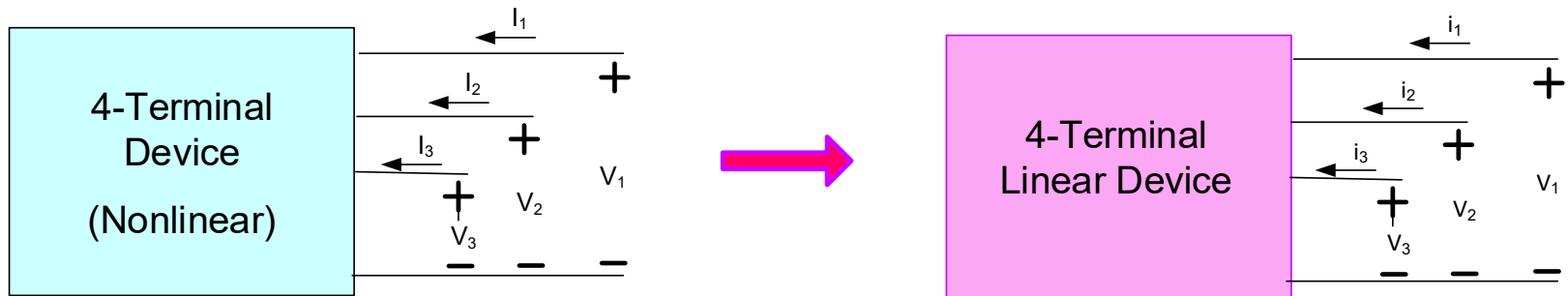

$$\left. \begin{aligned} I_1 &= \mathbf{f}_1(\mathbf{V}_1, \mathbf{V}_2, \mathbf{V}_3) \\ I_2 &= \mathbf{f}_2(\mathbf{V}_1, \mathbf{V}_2, \mathbf{V}_3) \\ I_3 &= \mathbf{f}_3(\mathbf{V}_1, \mathbf{V}_2, \mathbf{V}_3) \end{aligned} \right\}$$

$$\left. \begin{aligned} i_1 &= g_1(\mathbf{v}_1, \mathbf{v}_2, \mathbf{v}_3) \\ i_2 &= g_2(\mathbf{v}_1, \mathbf{v}_2, \mathbf{v}_3) \\ i_3 &= g_3(\mathbf{v}_1, \mathbf{v}_2, \mathbf{v}_3) \end{aligned} \right\}$$

Mapping is unique (with same models)

Small Signal Model

$$\mathbf{i}_1 = y_{11}\mathbf{u}_1 + y_{12}\mathbf{u}_2 + y_{13}\mathbf{u}_3$$

$$\mathbf{i}_2 = y_{21}\mathbf{u}_1 + y_{22}\mathbf{u}_2 + y_{23}\mathbf{u}_3$$

$$\mathbf{i}_3 = y_{31}\mathbf{u}_1 + y_{32}\mathbf{u}_2 + y_{33}\mathbf{u}_3$$

where

$$\mathbf{y}_{ij} = \left. \frac{\partial \mathbf{f}_i(\mathbf{V}_1, \mathbf{V}_2, \mathbf{V}_3)}{\partial \mathbf{V}_j} \right|_{\bar{\mathbf{V}} = \bar{\mathbf{V}}_Q}$$

- This is a small-signal model of a 4-terminal network and it is linear
- 9 small-signal parameters characterize the linear 4-terminal network
- Small-signal model parameters dependent upon Q-point !
- Termed the y-parameter model or “admittance” –parameter model

Review from Last Lecture

A small-signal equivalent circuit of a 4-terminal nonlinear network
(equivalent circuit because has exactly the same port equations)

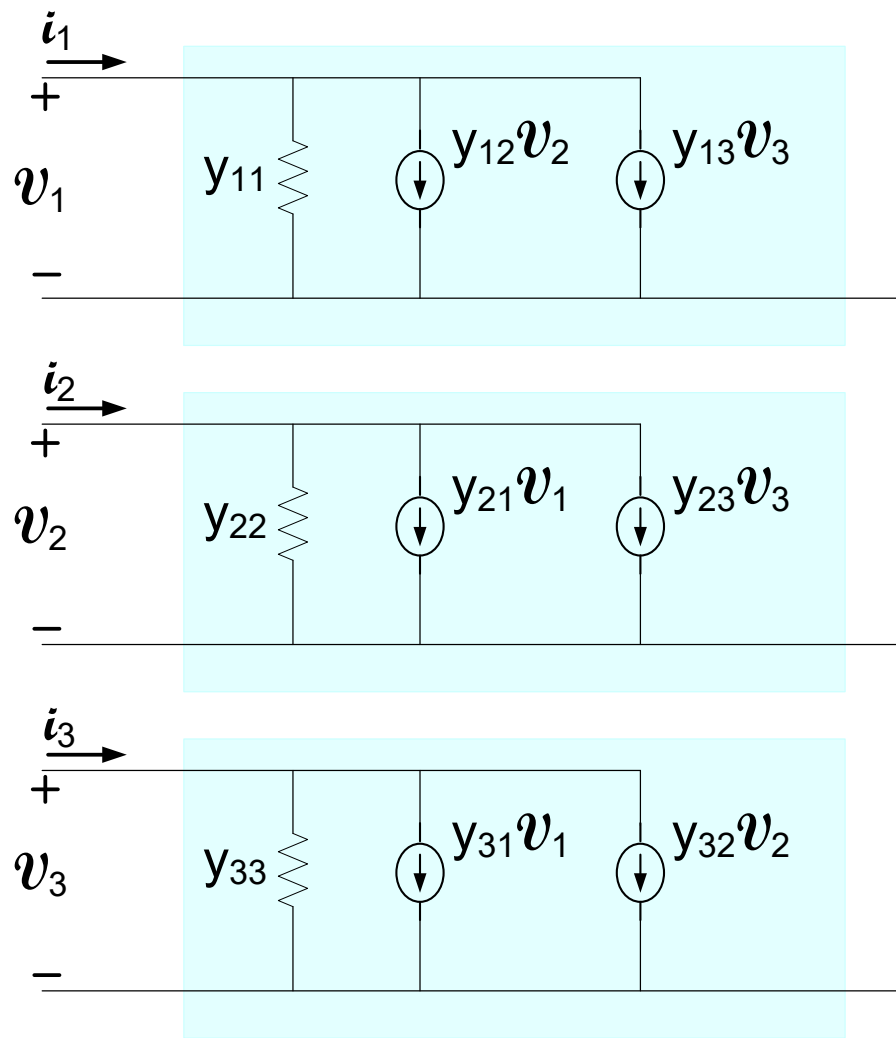

$$y_{ij} = \left. \frac{\partial f_i(\mathbf{V}_1, \mathbf{V}_2, \mathbf{V}_3)}{\partial \mathbf{V}_j} \right|_{\bar{\mathbf{V}} = \bar{\mathbf{V}}_Q}$$

Equivalent circuit is not unique
Equivalent circuit is a three-port network

Small-Signal Model

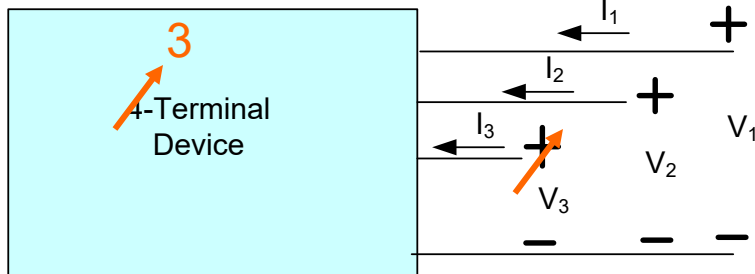

$$\left. \begin{aligned} \dot{i}_1 &= g_1(v_1, v_2, v_3) \\ \dot{i}_2 &= g_2(v_1, v_2, v_3) \\ \dot{i}_3 &= g_3(v_1, v_2, v_3) \end{aligned} \right\}$$

$$\dot{i}_1 = y_{11}v_1 + y_{12}v_2 + y_{13}v_3$$

$$\dot{i}_2 = y_{21}v_1 + y_{22}v_2 + y_{23}v_3$$

$$\dot{i}_3 = y_{31}v_1 + y_{32}v_2 + y_{33}v_3$$

$$y_{ij} = \left. \frac{\partial f_i(\mathbf{v}_1, \mathbf{v}_2, \mathbf{v}_3)}{\partial v_j} \right|_{\bar{\mathbf{v}} = \bar{\mathbf{v}}_Q}$$

Small-Signal Model

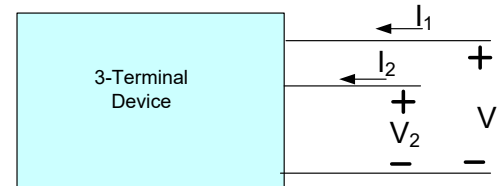

$$\begin{aligned} i_1 &= y_{11}v_1 + y_{12}v_2 \\ i_2 &= y_{21}v_1 + y_{22}v_2 \end{aligned}$$

$$y_{ij} = \left. \frac{\partial f_i(\mathbf{V}_1, \mathbf{V}_2)}{\partial \mathbf{V}_j} \right|_{\bar{\mathbf{V}} = \bar{\mathbf{V}}_Q}$$

$$\bar{\mathbf{V}} = \begin{pmatrix} \mathbf{V}_{1Q} \\ \mathbf{V}_{2Q} \end{pmatrix}$$

A Small Signal Equivalent Circuit (not unique)

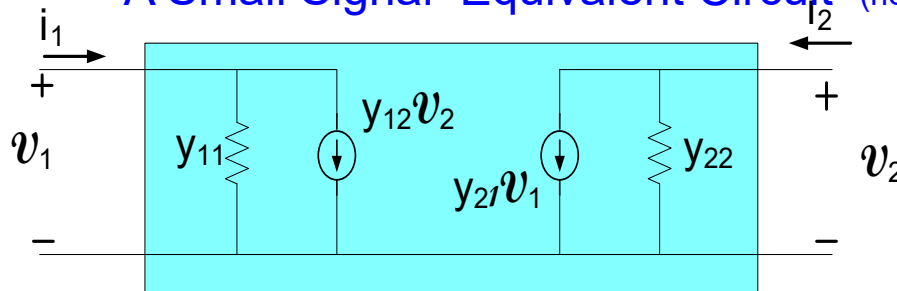

- *Small-signal model is a “two-port”*
- *4 small-signal parameters characterize this 3-terminal linear network*
- *Small signal parameters dependent upon Q-point*

Small-Signal Model

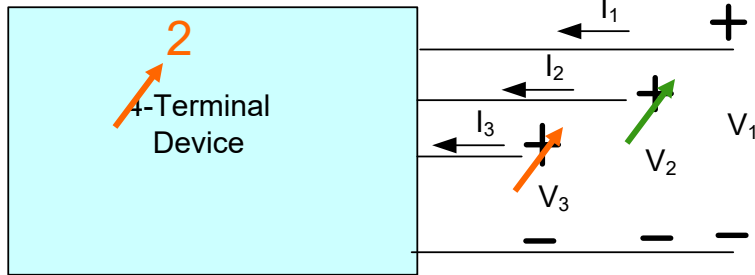

$$\dot{i}_1 = g_1(v_1, v_2, v_3)$$

$$\dot{i}_2 = g_2(v_1, v_2, v_3)$$

$$\dot{i}_3 = g_3(v_1, v_2, v_3)$$

$$\dot{i}_1 = y_{11}v_1 + y_{12}v_2 + y_{13}v_3$$

$$\dot{i}_2 = y_{21}v_1 + y_{22}v_2 + y_{23}v_3$$

$$\dot{i}_3 = y_{31}v_1 + y_{32}v_2 + y_{33}v_3$$

$$y_{ij} = \left. \frac{\partial f_i(\mathbf{V}_1, \mathbf{V}_2, \mathbf{V}_3)}{\partial V_j} \right|_{\bar{\mathbf{v}} = \bar{\mathbf{v}}_Q}$$

Small-Signal Model

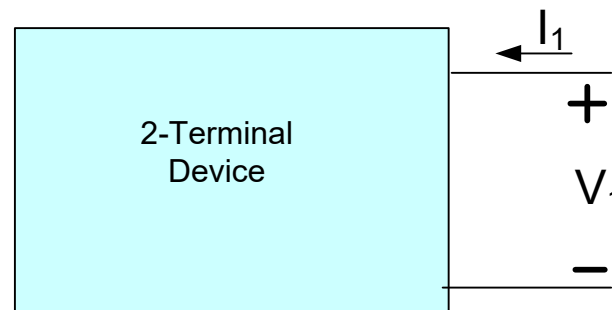

$$\mathbf{i}_1 = \mathbf{y}_{11} \mathbf{v}_1$$

$$\mathbf{y}_{11} = \left. \frac{\partial \mathbf{f}_1(V_1)}{\partial V_1} \right|_{\bar{V} = \bar{V}_Q} \quad \bar{V} = V_{1Q}$$

A Small Signal Equivalent Circuit

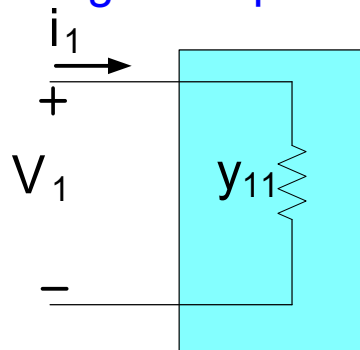

Small-signal model is a one-port

This was actually developed earlier !

Review from Last Lecture

Linearized nonlinear devices

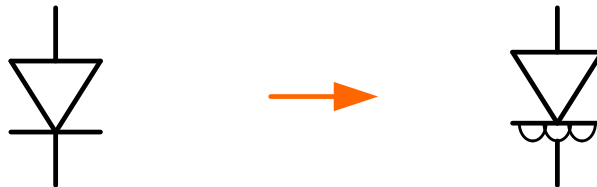
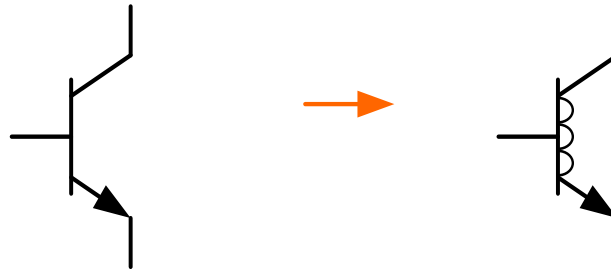
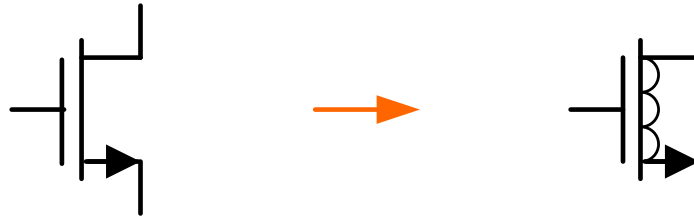
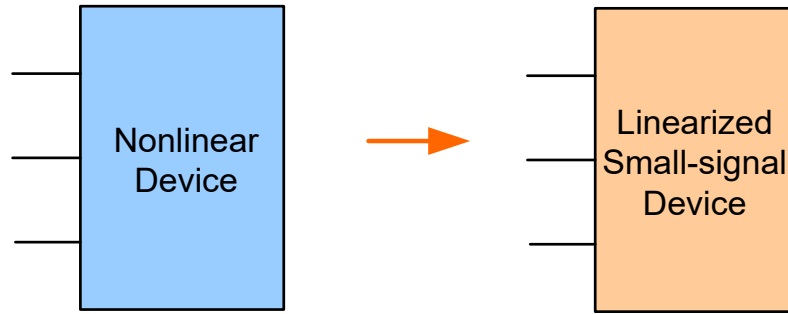

How is the small-signal equivalent circuit obtained from the nonlinear circuit?

What is the small-signal equivalent of the MOSFET, BJT, and diode ?

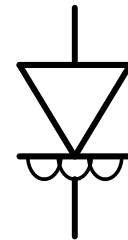
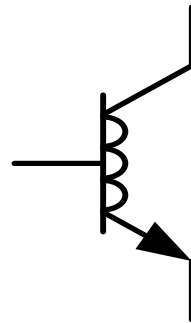
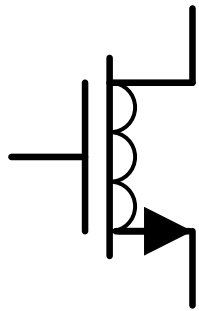

Small Signal Model of MOSFET

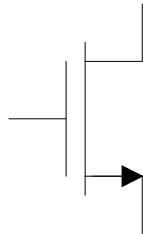

3-terminal device

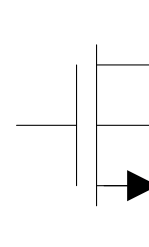

4-terminal device

MOSFET is actually a 4-terminal device but for many applications acceptable predictions of performance can be obtained by treating it as a 3-terminal device by neglecting the bulk terminal

In this course, we have been treating it as a 3-terminal device and in this lecture will develop the small-signal model by treating it as a 3-terminal device

When treated as a 4-terminal device, the bulk voltage introduces one additional term to the small signal model which is often either negligibly small or has no effect on circuit performance (will develop 4-terminal ss model later)

Small Signal Model of MOSFET

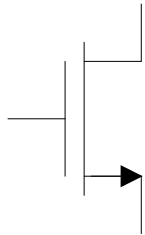

Large Signal Model

$$I_G = 0$$

3-terminal device

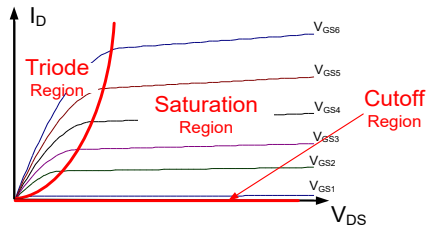

$$I_D = \begin{cases} 0 & V_{GS} \leq V_T \\ \mu C_{OX} \frac{W}{L} \left(V_{GS} - V_T - \frac{V_{DS}}{2} \right) V_{DS} & V_{GS} \geq V_T, V_{DS} < V_{GS} - V_T \\ \mu C_{OX} \frac{W}{2L} (V_{GS} - V_T)^2 (1 + \lambda V_{DS}) & V_{GS} \geq V_T, V_{DS} \geq V_{GS} - V_T \end{cases}$$

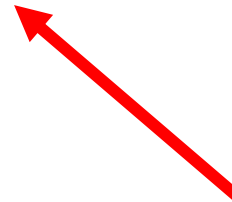

MOSFET is usually operated in saturation region in linear applications where a small-signal model is needed so will develop the small-signal model in the saturation region

Small Signal Model of MOSFET

$$I_1 = f_1(V_1, V_2) \quad \longleftrightarrow \quad I_G = 0$$

$$I_2 = f_2(V_1, V_2) \quad \longleftrightarrow \quad I_D = \mu C_{\text{OX}} \frac{W}{2L} (V_{\text{GS}} - V_{\text{T}})^2 (1 + \lambda V_{\text{DS}})$$

$$I_G = f_1(V_{\text{GS}}, V_{\text{DS}})$$

$$I_D = f_2(V_{\text{GS}}, V_{\text{DS}})$$

Small-signal model:

$$y_{ij} = \left. \frac{\partial f_i(V_1, V_2)}{\partial V_j} \right|_{\bar{V} = \bar{V}_Q}$$

$$y_{11} = \left. \frac{\partial I_G}{\partial V_{\text{GS}}} \right|_{\bar{V} = \bar{V}_Q}$$

$$y_{12} = \left. \frac{\partial I_G}{\partial V_{\text{DS}}} \right|_{\bar{V} = \bar{V}_Q}$$

$$y_{21} = \left. \frac{\partial I_D}{\partial V_{\text{GS}}} \right|_{\bar{V} = \bar{V}_Q}$$

$$y_{22} = \left. \frac{\partial I_D}{\partial V_{\text{DS}}} \right|_{\bar{V} = \bar{V}_Q}$$

Small Signal Model of MOSFET

$$I_G = 0$$

$$I_D = \mu C_{\text{ox}} \frac{W}{2L} (V_{\text{GS}} - V_T)^2 (1 + \lambda V_{\text{DS}})$$

Small-signal model:

$$y_{11} = \left. \frac{\partial I_G}{\partial V_{\text{GS}}} \right|_{\tilde{V} = \tilde{V}_Q} = ?$$

$$y_{12} = \left. \frac{\partial I_G}{\partial V_{\text{DS}}} \right|_{\tilde{V} = \tilde{V}_Q} = ?$$

$$y_{21} = \left. \frac{\partial I_D}{\partial V_{\text{GS}}} \right|_{\tilde{V} = \tilde{V}_Q} = ?$$

$$y_{22} = \left. \frac{\partial I_D}{\partial V_{\text{DS}}} \right|_{\tilde{V} = \tilde{V}_Q} = ?$$

Recall: termed the y-parameter model

Small Signal Model of MOSFET

$$I_1 = f_1(V_1, V_2) \quad \longleftrightarrow \quad I_G = 0$$

$$I_2 = f_2(V_1, V_2) \quad \longleftrightarrow \quad I_D = \mu C_{\text{ox}} \frac{W}{2L} (V_{\text{GS}} - V_{\text{T}})^2 (1 + \lambda V_{\text{DS}})$$

Small-signal model:

$$y_{11} = \left. \frac{\partial I_G}{\partial V_{\text{GS}}} \right|_{\tilde{V} = \tilde{V}_Q} = 0$$

$$y_{12} = \left. \frac{\partial I_G}{\partial V_{\text{DS}}} \right|_{\tilde{V} = \tilde{V}_Q} = 0$$

$$y_{21} = \left. \frac{\partial I_D}{\partial V_{\text{GS}}} \right|_{\tilde{V} = \tilde{V}_Q} = 2\mu C_{\text{ox}} \frac{W}{2L} (V_{\text{GS}} - V_{\text{T}})' (1 + \lambda V_{\text{DS}}) \Big|_{\tilde{V} = \tilde{V}_Q} = \mu C_{\text{ox}} \frac{W}{L} (V_{\text{GSQ}} - V_{\text{T}}) (1 + \lambda V_{\text{DSQ}})$$

$$y_{21} \cong \mu C_{\text{ox}} \frac{W}{L} (V_{\text{GSQ}} - V_{\text{T}})$$

$$y_{22} = \left. \frac{\partial I_D}{\partial V_{\text{DS}}} \right|_{\tilde{V} = \tilde{V}_Q} = \mu C_{\text{ox}} \frac{W}{2L} (V_{\text{GS}} - V_{\text{T}})^2 \lambda \Big|_{\tilde{V} = \tilde{V}_Q} \cong \lambda I_{\text{DQ}}$$

Small Signal Model of MOSFET

Nonlinear model:

$$I_G = 0$$

$$I_D = \mu C_{\text{ox}} \frac{W}{2L} (V_{\text{GS}} - V_{\text{T}})^2 (1 + \lambda V_{\text{DS}})$$

Small-signal model:

$$y_{11} = 0$$

$$y_{12} = 0$$

$$y_{21} \cong \mu C_{\text{ox}} \frac{W}{L} (V_{\text{GSQ}} - V_{\text{T}})$$

$$y_{22} \cong \lambda I_{\text{DQ}}$$

Small Signal Model of MOSFET

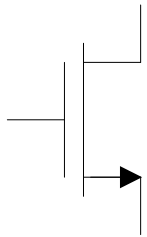

$$I_G = 0$$

$$I_D = \mu C_{\text{OX}} \frac{W}{2L} (V_{\text{GS}} - V_{\text{T}})^2 (1 + \lambda V_{\text{DS}})$$

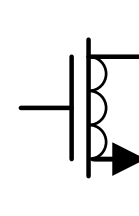

$$y_{12} = 0$$

$$y_{11} = 0$$

$$y_{21} \cong \mu C_{\text{OX}} \frac{W}{L} (V_{\text{GSQ}} - V_{\text{T}})$$

$$y_{22} \cong \lambda I_{\text{DQ}}$$

$$\begin{aligned} i_G &= y_{11} v_{\text{GS}} + y_{12} v_{\text{DS}} \\ i_D &= y_{21} v_{\text{GS}} + y_{22} v_{\text{DS}} \end{aligned}$$

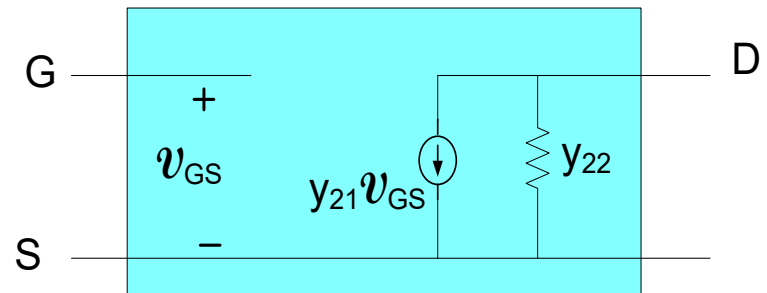

An equivalent circuit

(y-parameter model)

Small-Signal Model of MOSFET

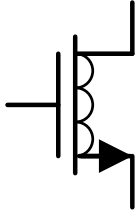

by convention, $y_{21}=g_m$, $y_{22}=g_o$

$$\therefore y_{21} \cong g_m = \mu C_{\text{ox}} \frac{W}{L} (V_{\text{GSQ}} - V_T)$$

$$y_{22} = g_o \cong \lambda I_{\text{DQ}}$$

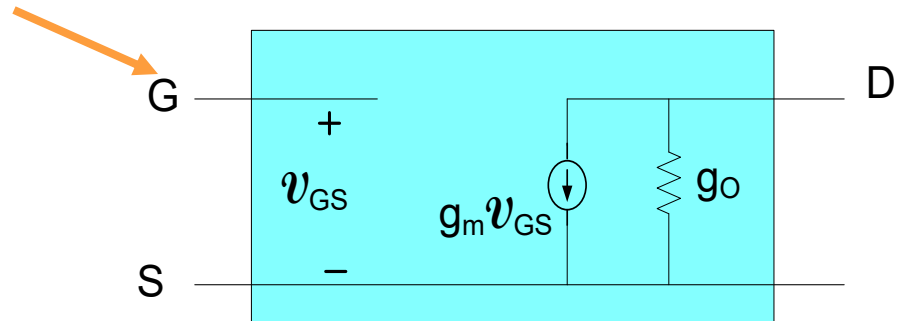
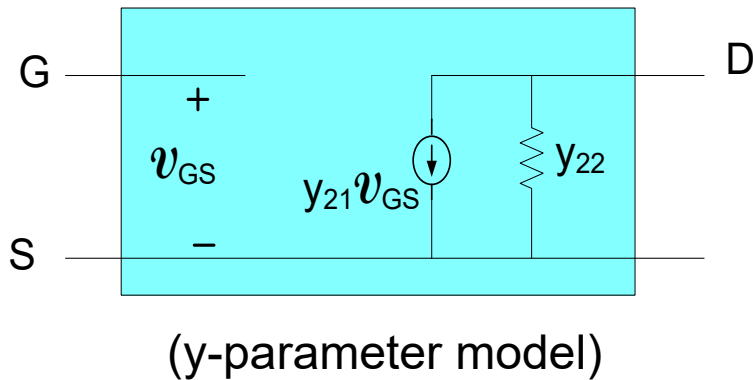

$$i_G = 0$$

$$i_D = g_m v_{GS} + g_o v_{DS}$$

Note: g_o vanishes when $\lambda=0$

still y-parameter model
but use “g” parameter notation

Small Signal Model of MOSFET

Saturation Region Summary

Nonlinear model:

$$\left\{ \begin{array}{l} I_G = 0 \\ I_D = \mu C_{\text{ox}} \frac{W}{2L} (V_{\text{GS}} - V_T)^2 (1 + \lambda V_{\text{DS}}) \end{array} \right.$$

Small-signal model:

$$\left\{ \begin{array}{l} i_G = y_{11} v_{\text{GS}} + y_{12} v_{\text{DS}} = 0 \\ i_D = y_{21} v_{\text{GS}} + y_{22} v_{\text{DSE}} \end{array} \right.$$

$$y_{11} = 0$$

$$y_{12} = 0$$

$$y_{21} = g_m \cong \mu C_{\text{ox}} \frac{W}{L} (V_{\text{GSQ}} - V_T)$$

$$y_{22} = g_0 \cong \lambda I_{\text{DQ}}$$

Small-Signal Model of MOSFET

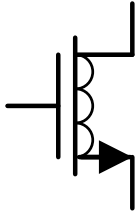

$$g_m = \mu C_{\text{ox}} \frac{W}{L} (V_{\text{GSQ}} - V_T)$$

$$g_o \cong \lambda I_{\text{DQ}}$$

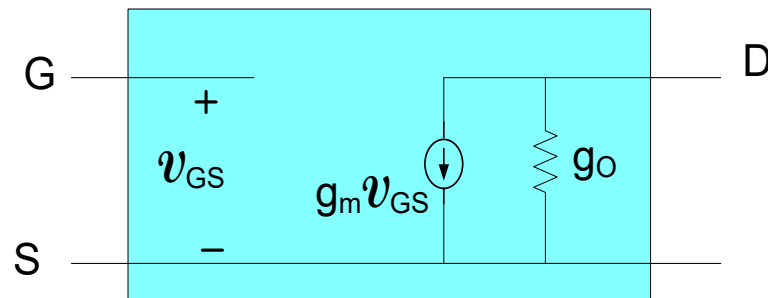

Alternate equivalent expressions for g_m :

$$I_{\text{DQ}} = \mu C_{\text{ox}} \frac{W}{2L} (V_{\text{GSQ}} - V_T)^2 (1 + \lambda V_{\text{DSQ}}) \cong \mu C_{\text{ox}} \frac{W}{2L} (V_{\text{GSQ}} - V_T)^2$$

$$g_m = \mu C_{\text{ox}} \frac{W}{L} (V_{\text{GSQ}} - V_T)$$

$$g_m = \sqrt{2\mu C_{\text{ox}} \frac{W}{L}} \cdot \sqrt{I_{\text{DQ}}}$$

$$g_m = \frac{2I_{\text{DQ}}}{V_{\text{GSQ}} - V_T}$$

Consider again:

Small-signal analysis example

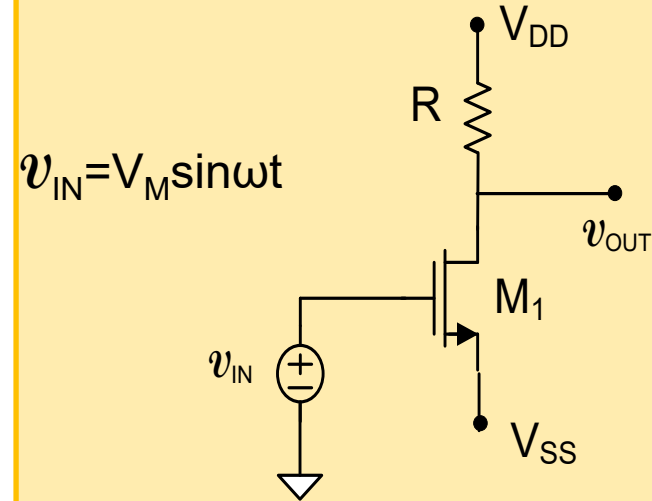

$$A_v = \frac{2I_{DQ} R}{[V_{SS} + V_T]}$$

Derived for $\lambda=0$ (equivalently $g_o=0$)

$$I_D = \mu C_{ox} \frac{W}{2L} (V_{GS} - V_T)^2$$

Recall the derivation was very tedious and time consuming!

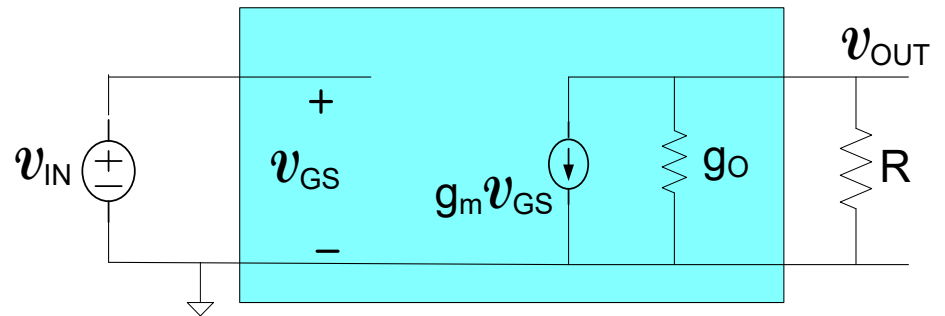
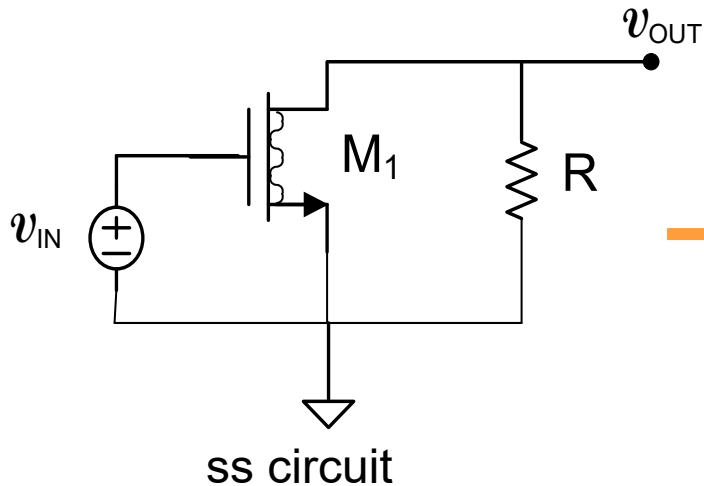

Consider again:

Small-signal analysis example

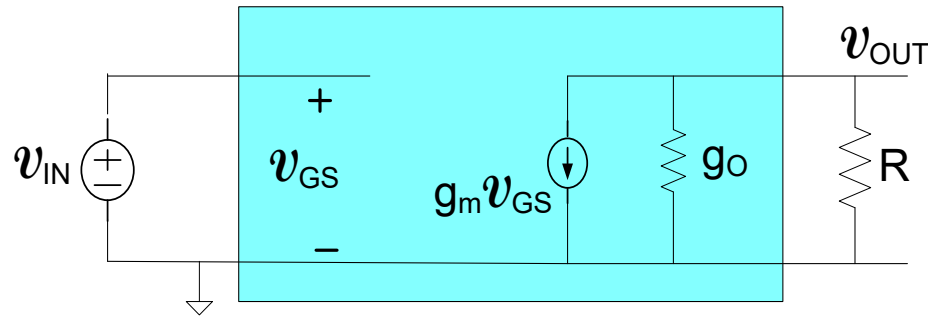
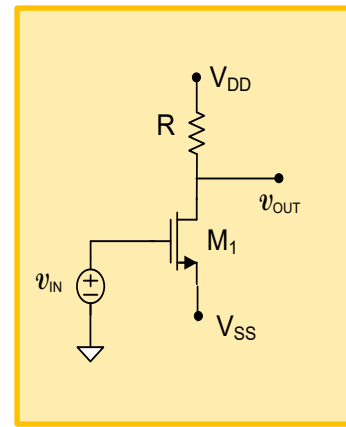

$$A_v = \frac{V_{OUT}}{V_{IN}} = -\frac{g_m}{g_o + 1/R}$$

This gain is expressed in terms of small-signal model parameters

For $\lambda=0$, $g_o = \lambda I_{DQ} = 0$

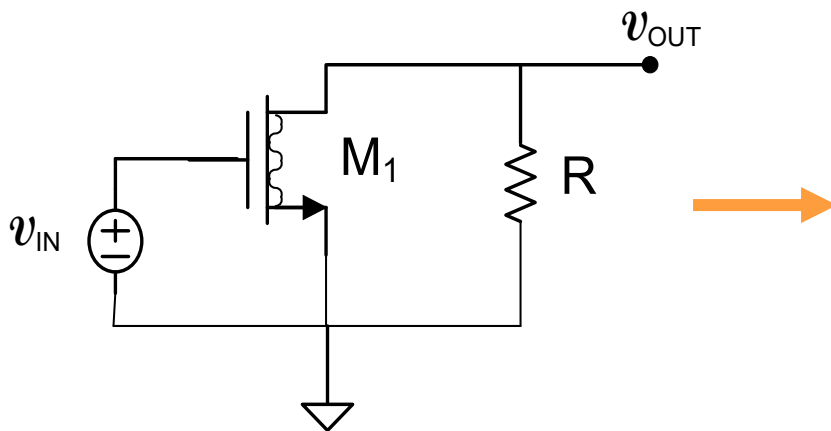

$$A_v = \frac{v_{OUT}}{v_{IN}} = -g_m R$$

$$\text{but } g_m = \frac{2I_{DQ}}{V_{GSQ} - V_T} \quad V_{GSQ} = -V_{SS}$$

thus

$$A_v = \frac{2I_{DQ} R}{[V_{SS} + V_T]}$$

Consider again:

Small-signal analysis example

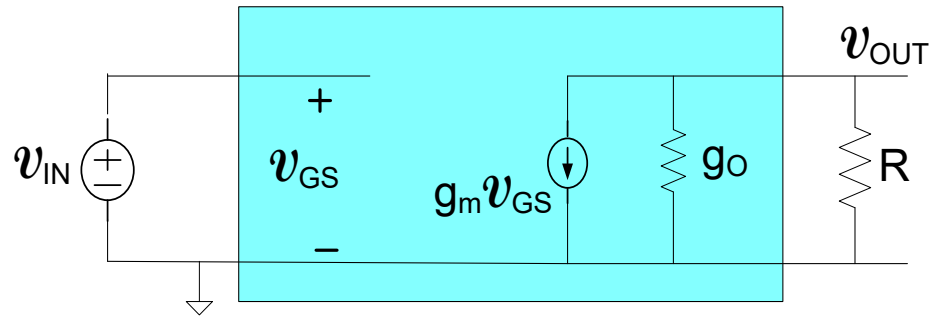

$$A_v = \frac{V_{OUT}}{V_{IN}} = -\frac{g_m}{g_o + 1/R}$$

For $\lambda=0$, $g_o = \lambda I_{DQ} = 0$

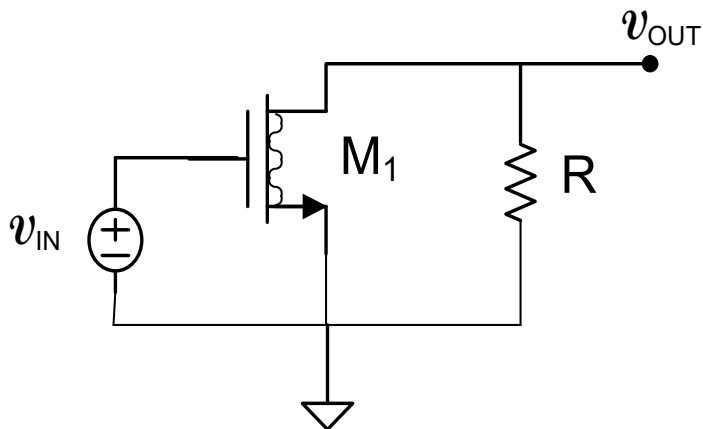

$$A_v = \frac{2I_{DQ} R}{[V_{SS} + V_T]}$$

- Same expression as derived before !
- More accurate gain can be obtained if λ effects are included and does not significantly increase complexity of small-signal analysis

Small Signal Model of BJT



3-terminal device

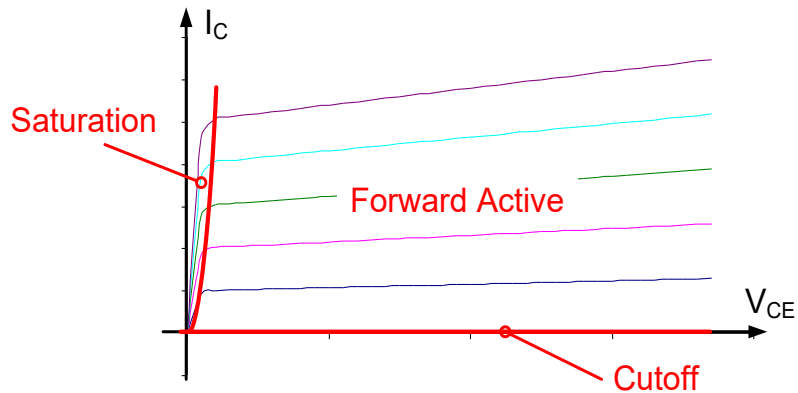

Forward Active Model:

$$I_C = J_S A_E e^{\frac{V_{BE}}{V_t}} \left(1 + \frac{V_{CE}}{V_{AF}} \right)$$

$$I_B = \frac{J_S A_E}{\beta} e^{\frac{V_{BE}}{V_t}}$$

- Usually operated in Forward Active Region when small-signal model is needed
- Will develop small-signal model in Forward Active Region

Small Signal Model of BJT

Nonlinear model:

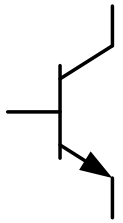

$$I_1 = f_1(V_1, V_2)$$



$$I_B = \frac{J_S A_E}{\beta} e^{\frac{V_{BE}}{V_t}}$$

$$I_2 = f_2(V_1, V_2)$$



$$I_C = J_S A_E e^{\frac{V_{BE}}{V_t}} \left(1 + \frac{V_{CE}}{V_{AF}} \right)$$

Small-signal model:

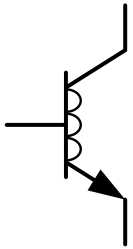

$$i_B = y_{11} v_{BE} + y_{12} v_{CE}$$

$$i_C = y_{21} v_{BE} + y_{22} v_{CE}$$

$$y_{ij} = \left. \frac{\partial f_i(V_1, V_2)}{\partial V_j} \right|_{\tilde{V} = \tilde{V}_Q} \quad \text{y-parameter model}$$

$$y_{11} = g_{\pi} = \left. \frac{\partial I_B}{\partial V_{BE}} \right|_{\tilde{V} = \tilde{V}_Q}$$

$$y_{12} = \left. \frac{\partial I_B}{\partial V_{CE}} \right|_{\tilde{V} = \tilde{V}_Q}$$

$$y_{21} = g_m = \left. \frac{\partial I_C}{\partial V_{BE}} \right|_{\tilde{V} = \tilde{V}_Q}$$

$$y_{22} = g_o = \left. \frac{\partial I_C}{\partial V_{CE}} \right|_{\tilde{V} = \tilde{V}_Q}$$

Note: g_m , g_{π} and g_o used for notational consistency with legacy terminology

Small Signal Model of BJT

Nonlinear model:

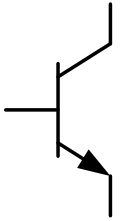

$$I_B = \frac{J_S A_E}{\beta} e^{\frac{V_{BE}}{V_t}}$$

$$I_C = J_S A_E e^{\frac{V_{BE}}{V_t}} \left(1 + \frac{V_{CE}}{V_{AF}} \right)$$

Small-signal model:

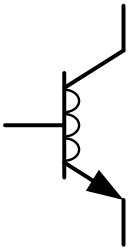

$$i_B = y_{11} v_{BE} + y_{12} v_{CE}$$

$$i_C = y_{21} v_{BE} + y_{22} v_{CE}$$

$$y_{ij} = \left. \frac{\partial f_i(V_1, V_2)}{\partial V_j} \right|_{\vec{V} = \vec{V}_Q}$$

$$y_{11} = g_\pi = \left. \frac{\partial I_B}{\partial V_{BE}} \right|_{\vec{V} = \vec{V}_Q} = ?$$

$$y_{12} = \left. \frac{\partial I_B}{\partial V_{CE}} \right|_{\vec{V} = \vec{V}_Q} = ?$$

$$y_{21} = g_m = \left. \frac{\partial I_C}{\partial V_{BE}} \right|_{\vec{V} = \vec{V}_Q} = ?$$

$$y_{22} = g_o = \left. \frac{\partial I_C}{\partial V_{CE}} \right|_{\vec{V} = \vec{V}_Q} = ?$$

Small Signal Model of BJT

Nonlinear model:

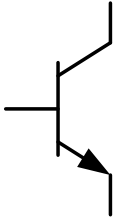

$$I_B = \frac{J_S A_E}{\beta} e^{\frac{V_{BE}}{V_t}}$$

$$I_C = J_S A_E e^{\frac{V_{BE}}{V_t}} \left(1 + \frac{V_{CE}}{V_{AF}} \right)$$

Small-signal model:

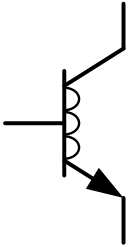

$$i_B = y_{11} v_{BE} + y_{12} v_{CE}$$

$$i_C = y_{21} v_{BE} + y_{22} v_{CE}$$

$$y_{11} = g_\pi = \left. \frac{\partial I_B}{\partial V_{BE}} \right|_{\hat{V}=\hat{V}_Q} = \frac{1}{V_t} \frac{J_S A_E}{\beta} e^{\frac{V_{BE}}{V_t}} \Big|_{\hat{V}=\hat{V}_Q} = \frac{I_{BQ}}{V_t} \cong \frac{I_{CQ}}{\beta V_t}$$

$$y_{21} = g_m = \left. \frac{\partial I_C}{\partial V_{BE}} \right|_{\hat{V}=\hat{V}_Q} = \frac{1}{V_t} J_S A_E e^{\frac{V_{BE}}{V_t}} \left(1 + \frac{V_{CE}}{V_{AF}} \right) \Big|_{\hat{V}=\hat{V}_Q} = \frac{I_{CQ}}{V_t}$$

$$y_{12} = \left. \frac{\partial I_B}{\partial V_{CE}} \right|_{\hat{V}=\hat{V}_Q} = 0$$

$$y_{22} = g_o = \left. \frac{\partial I_C}{\partial V_{CE}} \right|_{\hat{V}=\hat{V}_Q} = \frac{J_S A_E e^{\frac{V_{BE}}{V_t}}}{V_{AF}} \Big|_{\hat{V}=\hat{V}_Q} \cong \frac{I_{CQ}}{V_{AF}}$$

Note: usually prefer to express in terms of I_{CQ}

Small Signal Model of BJT

Forward Active Region Summary

Nonlinear model:

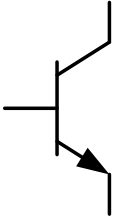

$$\left\{ \begin{aligned} I_B &= \frac{J_S A_E}{\beta} e^{\frac{V_{BE}}{V_t}} \\ I_C &= J_S A_E e^{\frac{V_{BE}}{V_t}} \left(1 + \frac{V_{CE}}{V_{AF}} \right) \end{aligned} \right.$$

Small-signal model:

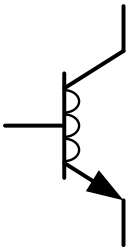

$$\left\{ \begin{aligned} \mathbf{i}_B &= y_{11} \mathbf{v}_{BE} + y_{12} \mathbf{v}_{CE} \\ \mathbf{i}_C &= y_{21} \mathbf{v}_{BE} + y_{22} \mathbf{v}_{CE} \end{aligned} \right.$$

$$y_{11} = g_{\pi} \cong \frac{I_{CQ}}{\beta V_t}$$

$$y_{12} = 0$$

$$y_{21} = g_m = \frac{I_{CQ}}{V_t}$$

$$y_{22} = g_o \cong \frac{I_{CQ}}{V_{AF}}$$

Small Signal Model of BJT

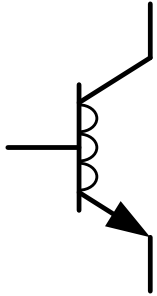

$$\begin{aligned} i_B &= y_{11} v_{BE} + y_{12} v_{CE} \\ i_C &= y_{21} v_{BE} + y_{22} v_{CE} \end{aligned}$$



$$\begin{aligned} i_B &= g_\pi v_{BE} \\ i_C &= g_m v_{BE} + g_o v_{CE} \end{aligned}$$

$$g_\pi = \frac{I_{CQ}}{\beta V_t}$$

$$g_m = \frac{I_{CQ}}{V_t}$$

$$g_o = \frac{I_{CQ}}{V_{AF}}$$

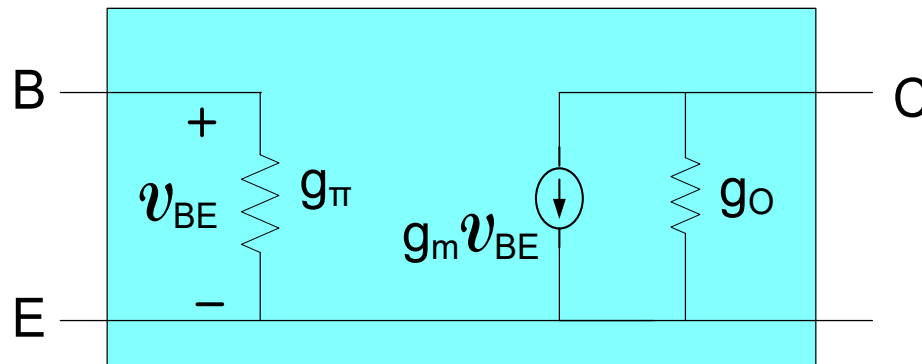

An equivalent circuit

y-parameter model using “g” parameter notation

Consider again:

Small signal analysis example

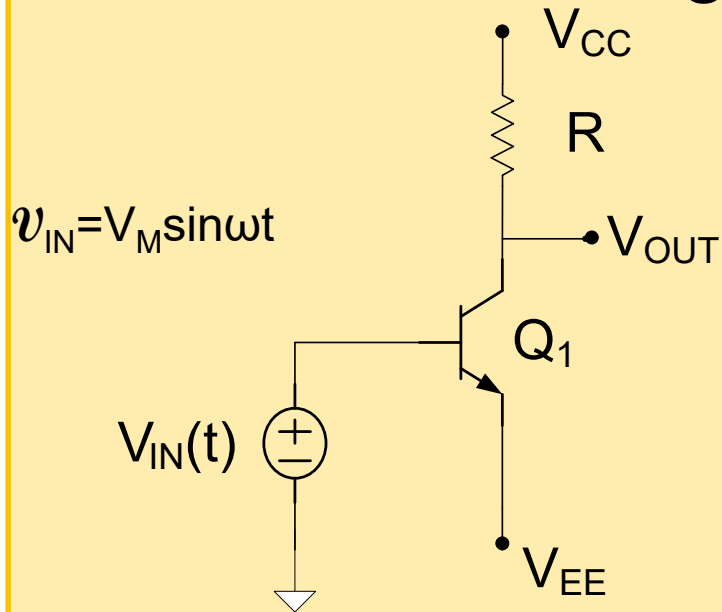

$$A_{vB} = -\frac{I_{CQ} R}{V_t}$$

Derived for $V_{AF}=0$ (equivalently $g_o=0$)

Recall the derivation was very tedious and time consuming!

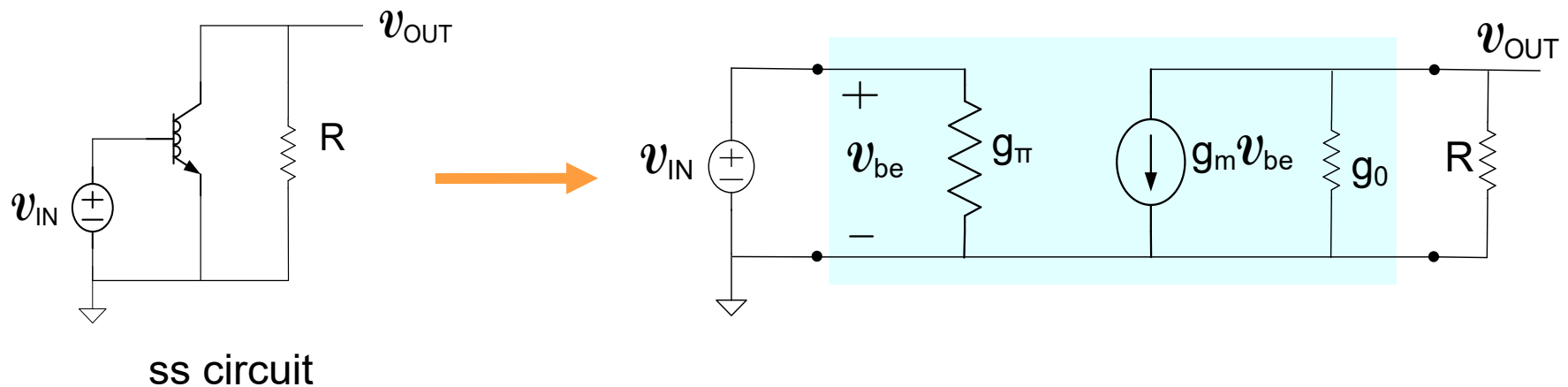

Neglect V_{AF} effects (i.e. $V_{AF} = \infty$) to be consistent with earlier analysis

$$g_o = \frac{I_{CQ}}{V_{AF}} \Big|_{V_{AF} = \infty} = 0$$

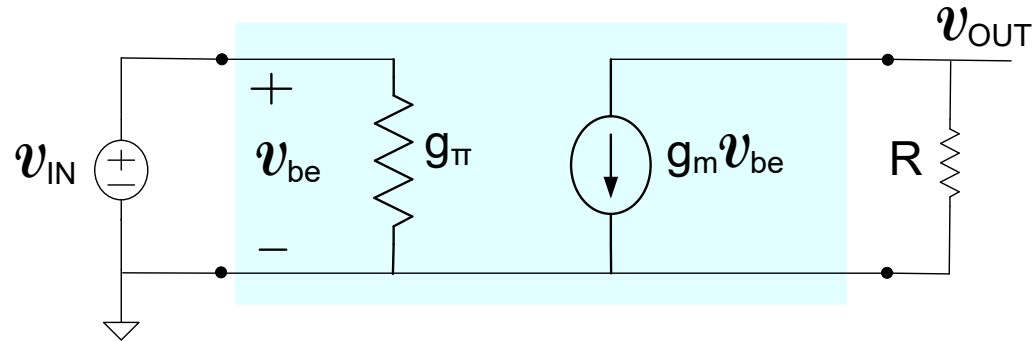
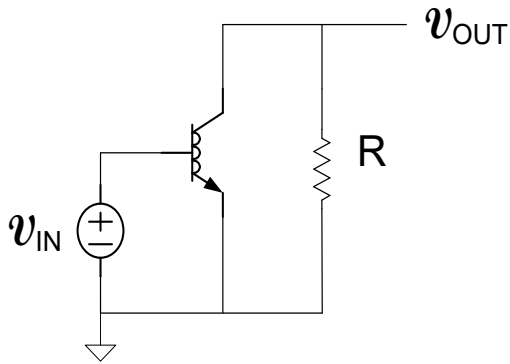

$$\left. \begin{aligned} v_{OUT} &= -g_m R v_{BE} \\ v_{IN} &= v_{BE} \end{aligned} \right\}$$

$$A_V = \frac{v_{OUT}}{v_{IN}} = -g_m R$$

$$g_m = \frac{I_{CQ}}{V_t}$$

$$A_V = -\frac{I_{CQ} R}{V_t}$$

Note this is identical to what was obtained with the direct nonlinear analysis

Small Signal BJT Model – alternate representation

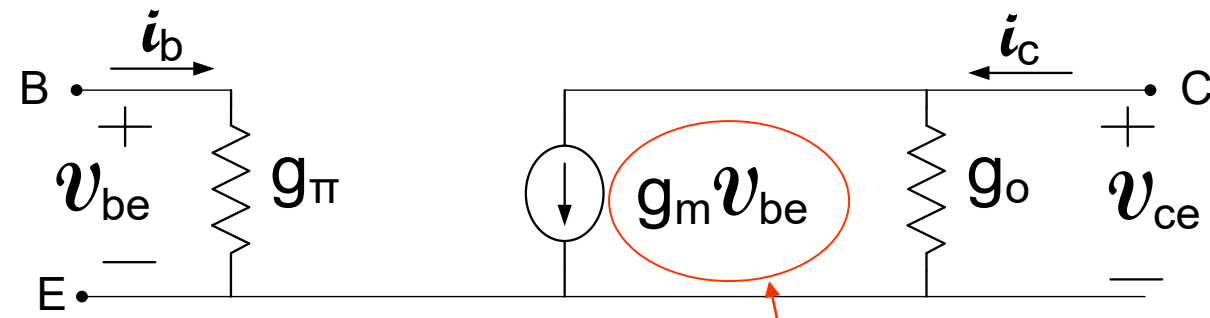

$$g_m = \frac{I_{CQ}}{V_t} \quad g_\pi = \frac{I_{CQ}}{\beta V_t} \quad g_o \cong \frac{I_{CQ}}{V_{AF}}$$

Observe :

$$g_\pi v_{be} = i_b$$

$$g_m v_{be} = i_b \frac{g_m}{g_\pi}$$

$$\frac{g_m}{g_\pi} = \frac{\left[\frac{I_Q}{V_t} \right]}{\left[\frac{I_Q}{\beta V_t} \right]} = \beta$$

$$g_m v_{be} = \beta i_b$$

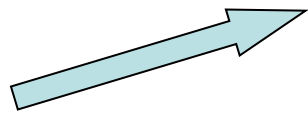

Can replace the voltage dependent current source with a current dependent current source

Small Signal BJT Model – alternate representation

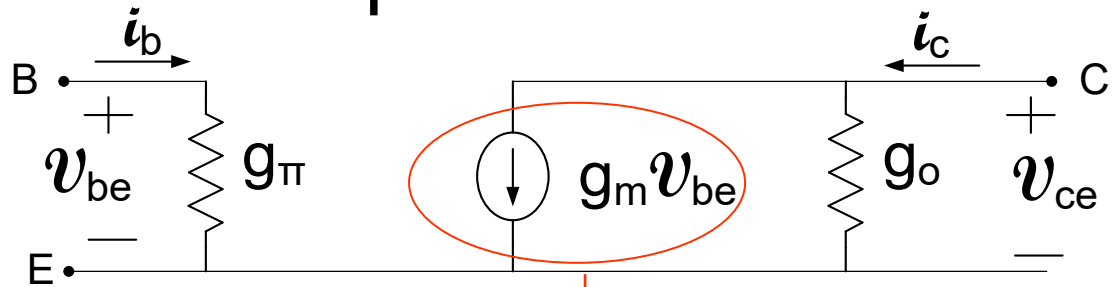

$$g_m = \frac{I_{CQ}}{V_t}$$

$$g_{\pi} = \frac{I_{CQ}}{\beta V_t}$$

$$g_o \cong \frac{I_{CQ}}{V_{AF}}$$

Alternate equivalent small signal model

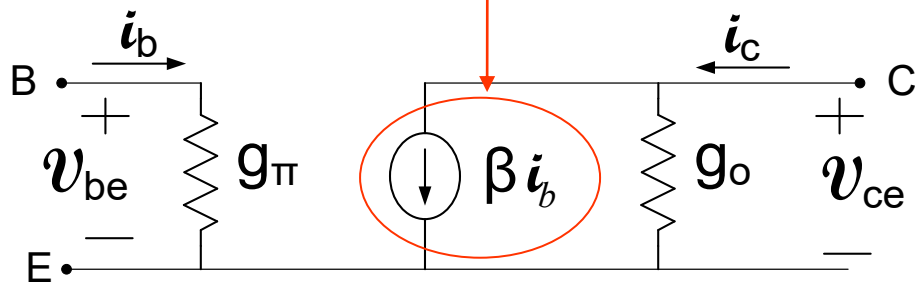

$$g_{\pi} = \frac{I_{CQ}}{\beta V_t}$$

$$g_o \cong \frac{I_{CQ}}{V_{AF}}$$

Small-Signal Model Representations

(3-terminal network – also relevant with 4-terminal networks)

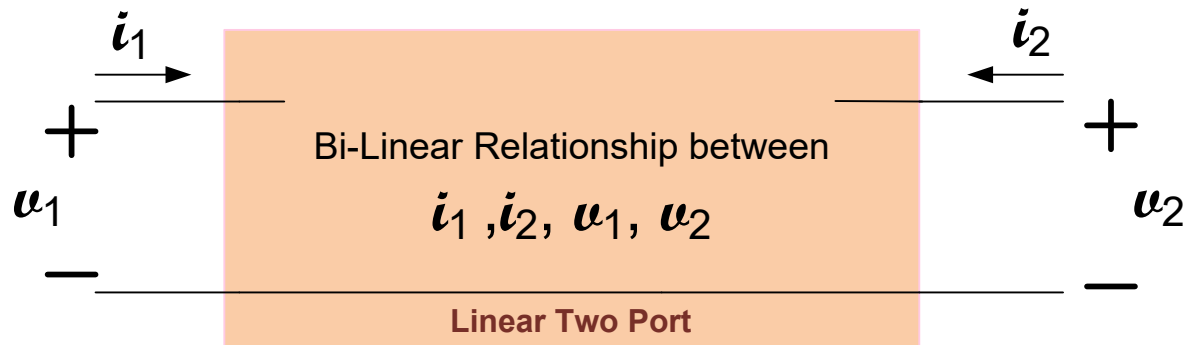

- Have developed small-signal models for the MOSFET and BJT
- Models have been based upon arbitrary assumption that u_1, u_2 are independent variables
- Models are y-parameter models expressed in terms of “g” parameters
- Have already seen some alternatives for “parameter” definitions in these models
- Alternative representations are sometimes used

Small-Signal Model Representations

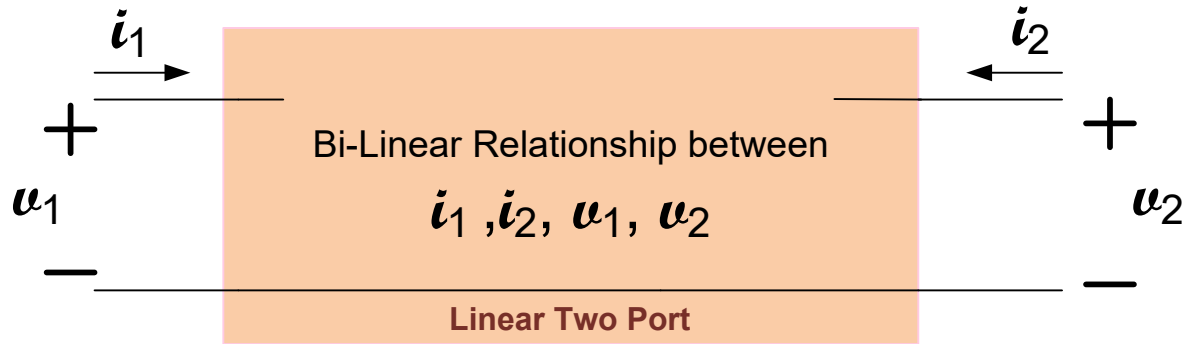

The good, the bad, and the unnecessary !!

what we have developed:

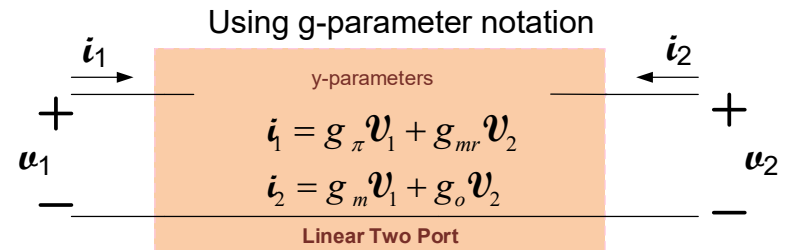
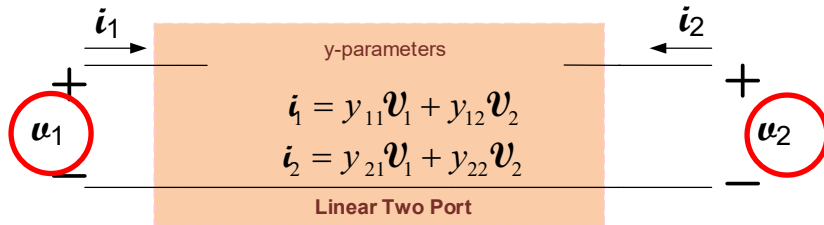

The hybrid parameters:

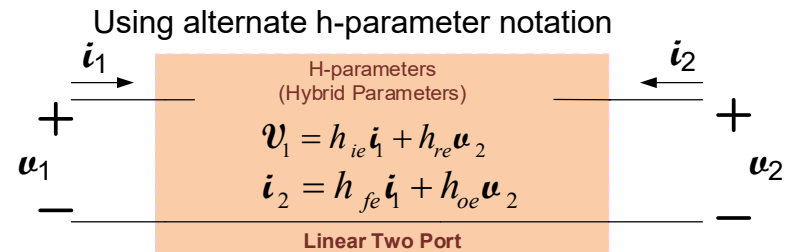
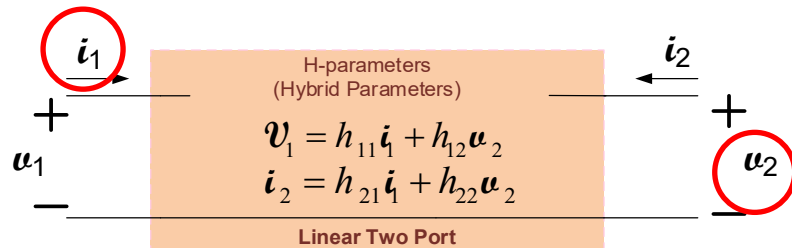

Independent parameters ○

Small-Signal Model Representations

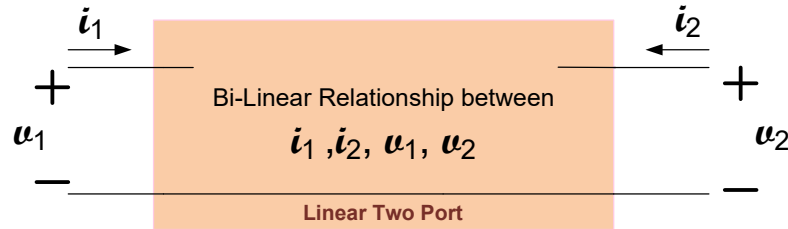

The z-parameters

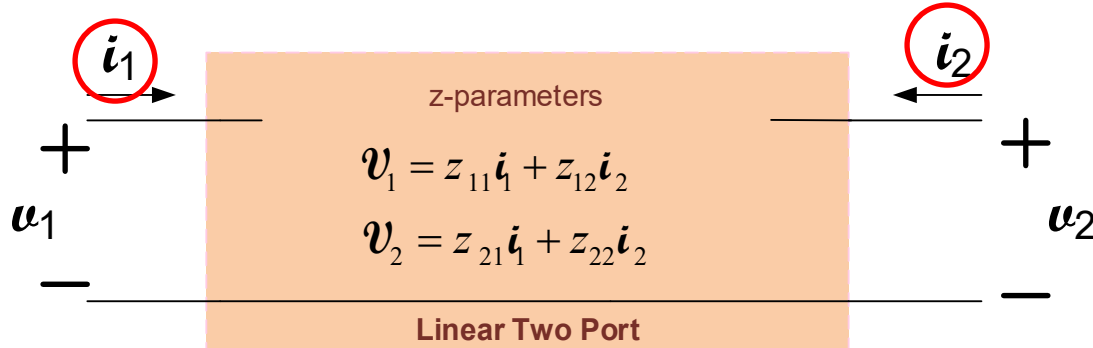

The ABCD parameters:

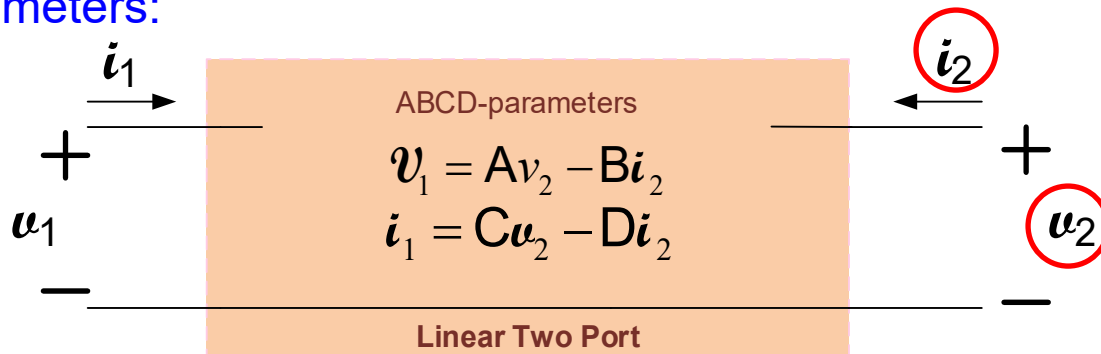

Small-Signal Model Representations

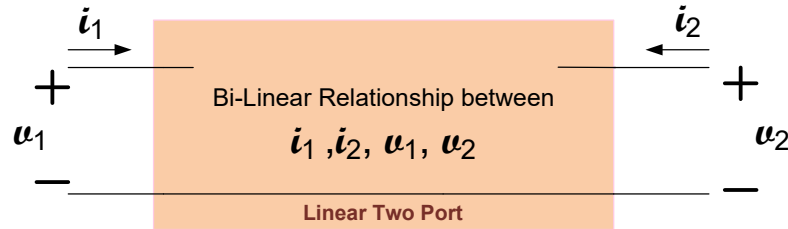

Amplifier parameters

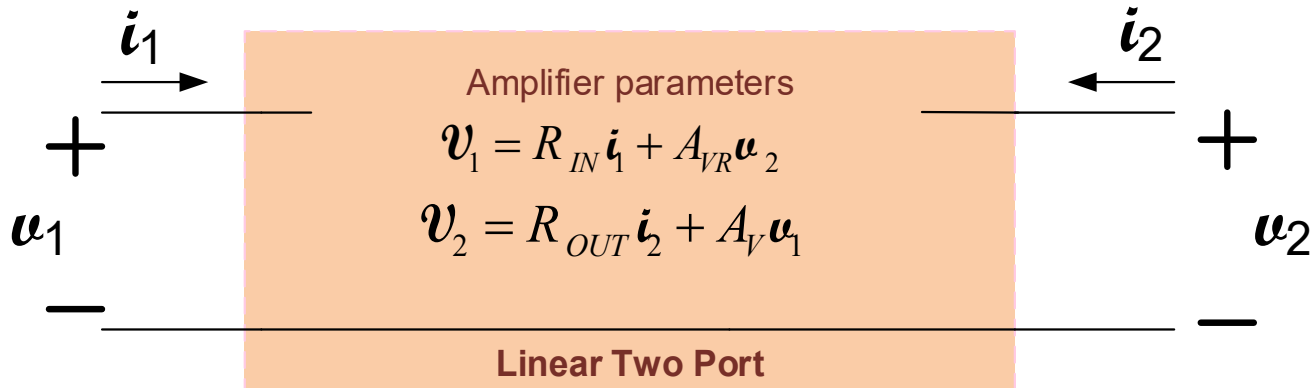

- Alternate two-port characterization but not expressed in terms of independent and dependent parameters
- Widely used notation when designing amplifiers

Small-Signal Model Representations

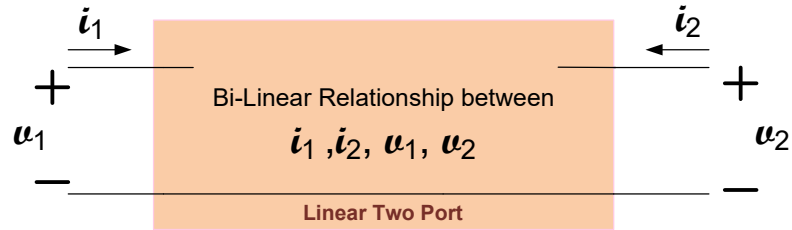

The S-parameters

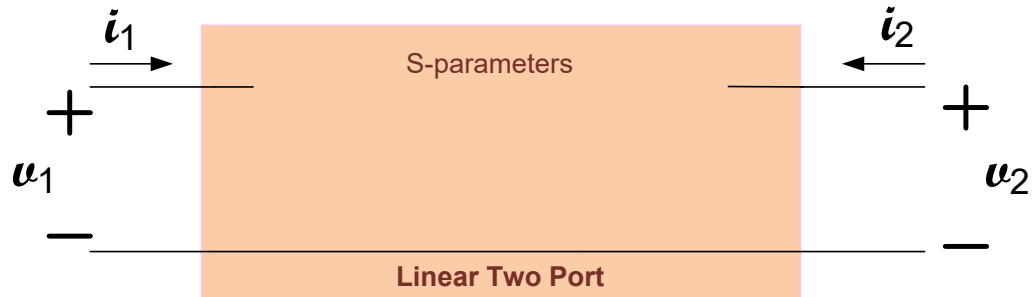

(embedded with source and load impedances)

The T parameters:

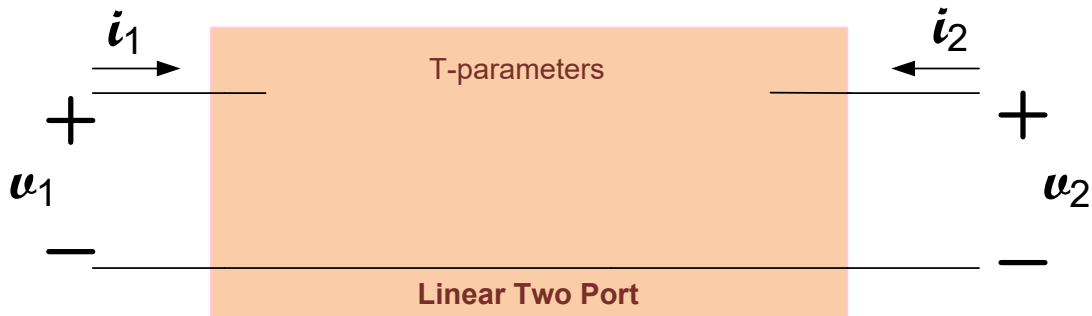

(embedded with source and load impedances)

Small-Signal Model Representations

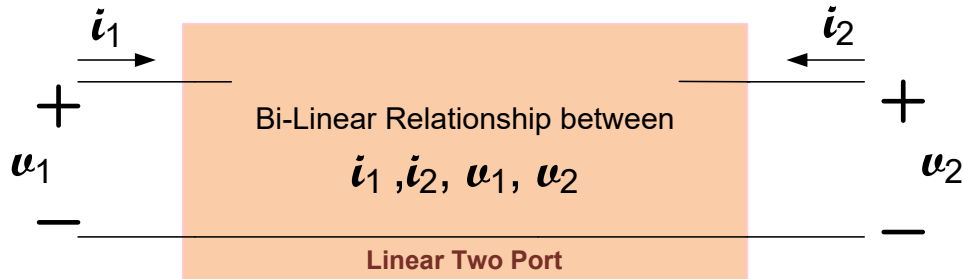

The good, the bad, and the **unnecessary** !!

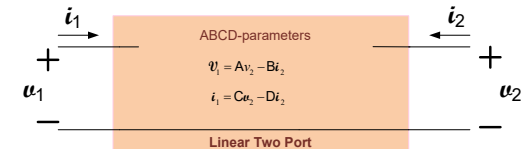
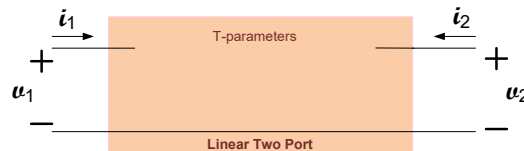
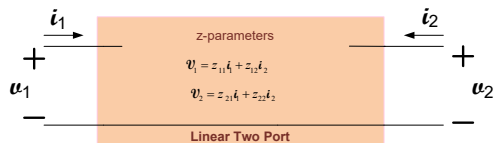
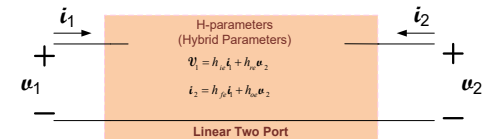
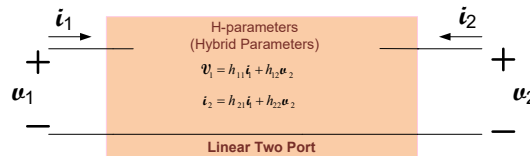
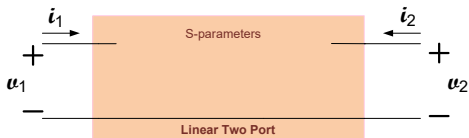
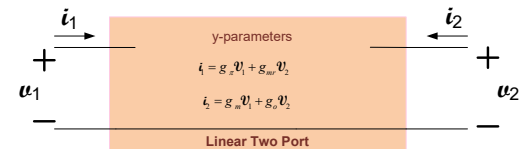
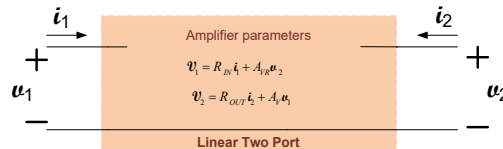
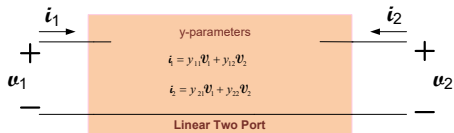

- Equivalent circuits often given for each representation
- All provide identical characterization
- Easy to move from any one to another

Small-Signal Model Representations

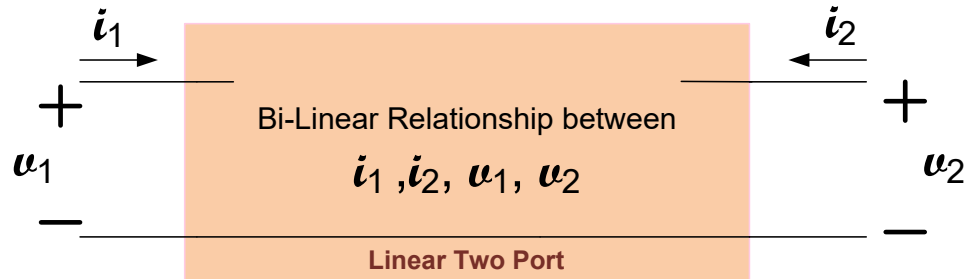

The good, the bad, and the **unnecessary** !!

IEEE TRANSACTIONS ON MICROWAVE THEORY AND TECHNIQUES, VOL. 42, NO. 2, FEBRUARY 1994

Conversions Between S , Z , Y , h , $ABCD$, and T Parameters which are Valid for Complex Source and Load Impedances

Dean A. Frickey, *Member, IEEE*

Conversions **between S, Z, Y, H, ABCD**, and T parameters which are valid for complex source and load impedances

[DA Frickey - IEEE Transactions on microwave theory and ..., 1994 - ieeexplore.ieee.org](#)

... 2. FEBRUARY 1994 TABLE m EQUATIONS FOR THE **CONVERSION BETWEEN s** PARAMETIERS

AND NORMALIZED 2, Y, h ... V. CONCLUSION This paper developed the equations for **conversion between the various common 2-port parameters, Z, Y, h, ABCD, S, and T ...**

☆ [Cited by 575](#) Related articles All 7 versions

[Comments on "Conversions between S, Z, Y, h, ABCD, and T parameters which are valid for complex source and load impedances"\[with reply\]](#)
... DF Williams, [DA Frickey](#) - IEEE Transactions on ..., 1995 - ieeexplore.ieee.org
In his recent paper, Frickey presents formulas for conversions between various network matrices. Four of these matrices (Z, Y, h, and ABCD) relate voltages and currents at the ports; the other two (S and T) relate wave quantities. These relationships depend on the ...
☆ [Cited by 56](#) Related articles All 4 versions

Small-Signal Model Representations

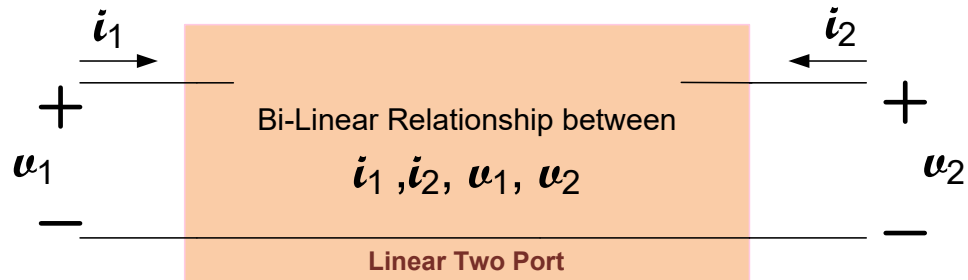

The good, the bad, and the **unnecessary** !!

IEEE TRANSACTIONS ON MICROWAVE THEORY AND TECHNIQUES, VOL. 42, NO. 2, FEBRUARY 1994

Conversions Between S , Z , Y , h , $ABCD$, and T Parameters which are Valid for Complex Source and Load Impedances

Conversions **between** S , Z , Y , H , $ABCD$, and T parameters which are valid for complex source and load impedances

DA Frickey - IEEE Transactions on microwave theory and ..., 1994 - ieeexplore.ieee.org

This paper provides tables which contain the conversion between the various common two-port parameters, Z , Y , H , $ABCD$, S , and T . The conversions are valid for complex normalizing impedances. An example is provided which verifies the conversions to and from S

☆ 99 Cited by 370 Related articles All 5 versions

Small-Signal Model Representations

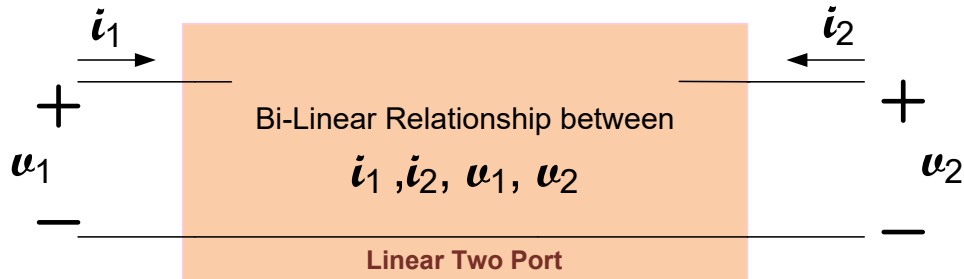

The good, the bad, and the **unnecessary** !!

IEEE TRANSACTIONS ON MICROWAVE THEORY AND TECHNIQUES, VOL. 42, NO. 2, FEBRUARY 1994

Conversions Between S , Z , Y , h , $ABCD$, and T Parameters which are Valid for Complex Source and Load Impedances

Dean A. Frickey, *Member, IEEE*

[Conversions between S, Z, Y, H, ABCD, and T parameters which are valid for complex source and load impedances](#)

DA Frickey - IEEE Transactions on Microwave Theory and ..., 1994 - osti.gov

Conversions between S, Z, Y, h, ABCD, and T parameters which are valid for complex source and load impedances This paper provides tables which contain the **conversion between** the various common two-port parameters, Z, Y, h, ABCD, S, and T. The ...

[Cited by 226](#) [Related articles](#) [All 6 versions](#) [Cite](#) [Save](#) [More](#)

Comments on "[Conversions between S, Z, Y, h, ABCD, and T parameters which are valid for complex source and load impedances](#)"[with reply]

[nist.gov \[PDF\]](#)

..., DF Williams, DA Frickey - Microwave Theory and ..., 1995 - ieeexplore.ieee.org

In his recent paper, Frickey presents formulas for **conversions between** various network matrices. Four of these matrices (Z, Y, h, and ABCD) relate voltages and currents at the ports; the other two (S and T) relate wave quantities. These relationships depend on the ...

[Cited by 30](#) [Related articles](#) [All 3 versions](#) [Cite](#) [Save](#)

Small-Signal Model Representations

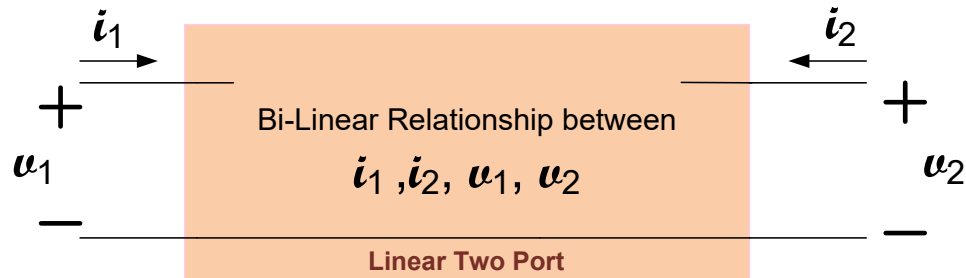

The good, the bad, and the **unnecessary** !!

IEEE TRANSACTIONS ON MICROWAVE THEORY AND TECHNIQUES, VOL. 42, NO. 2, FEBRUARY 1994

Conversions Between S , Z , Y , h , $ABCD$, and T Parameters which are Valid for Complex Source and Load Impedances

Dean A. Frickey, *Member, IEEE*





[Conversions between S, Z, Y, H, ABCD, and T parameters which are valid for complex source and load impedances](#)

DA Frickey - ... theory and techniques, IEEE Transactions on, 1994 - [ieeexplore.ieee.org](#)

Abstract This paper provides tables which contain the **conversion between** the various common two-port parameters, Z, Y, H, ABCD, S, and T. The **conversions** are valid for complex normalizing impedances. An example is provided which verifies the **conversions** ...

[Cited by 149](#) [Related articles](#) [All 5 versions](#) [Cite](#)

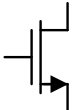
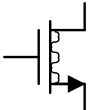
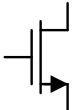
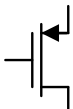
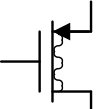
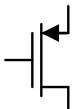
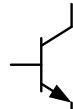
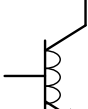
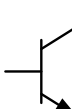
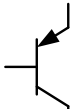
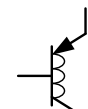
Active Device Model Summary

	Element	ss equivalent	dc equivalent
Diodes			 Simplified
MOS transistors			 Simplified
			 Simplified
Bipolar Transistors			 Simplified
			 Simplified

What are the simplified dc equivalent models?

Active Device Model Summary

What are the simplified dc equivalent models?

dc equivalent

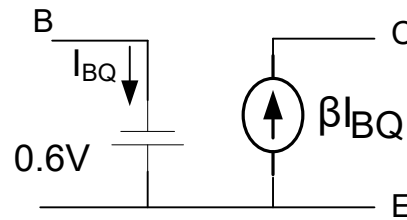
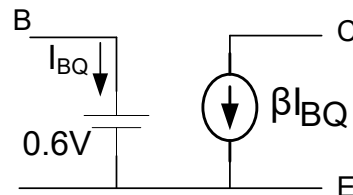
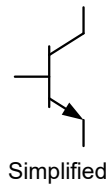
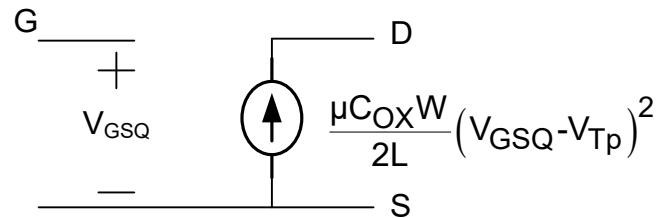
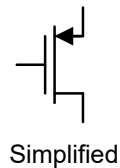
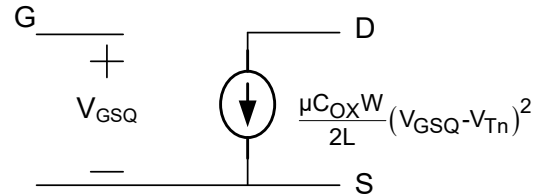
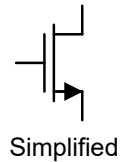
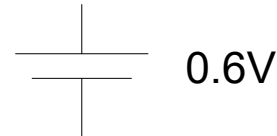
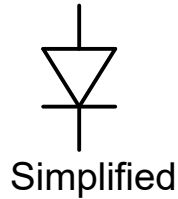

Example: Determine the small signal voltage gain $A_V = v_{OUT}/v_{IN}$. Assume M_1 and M_2 are operating in the saturation region and that $\lambda=0$

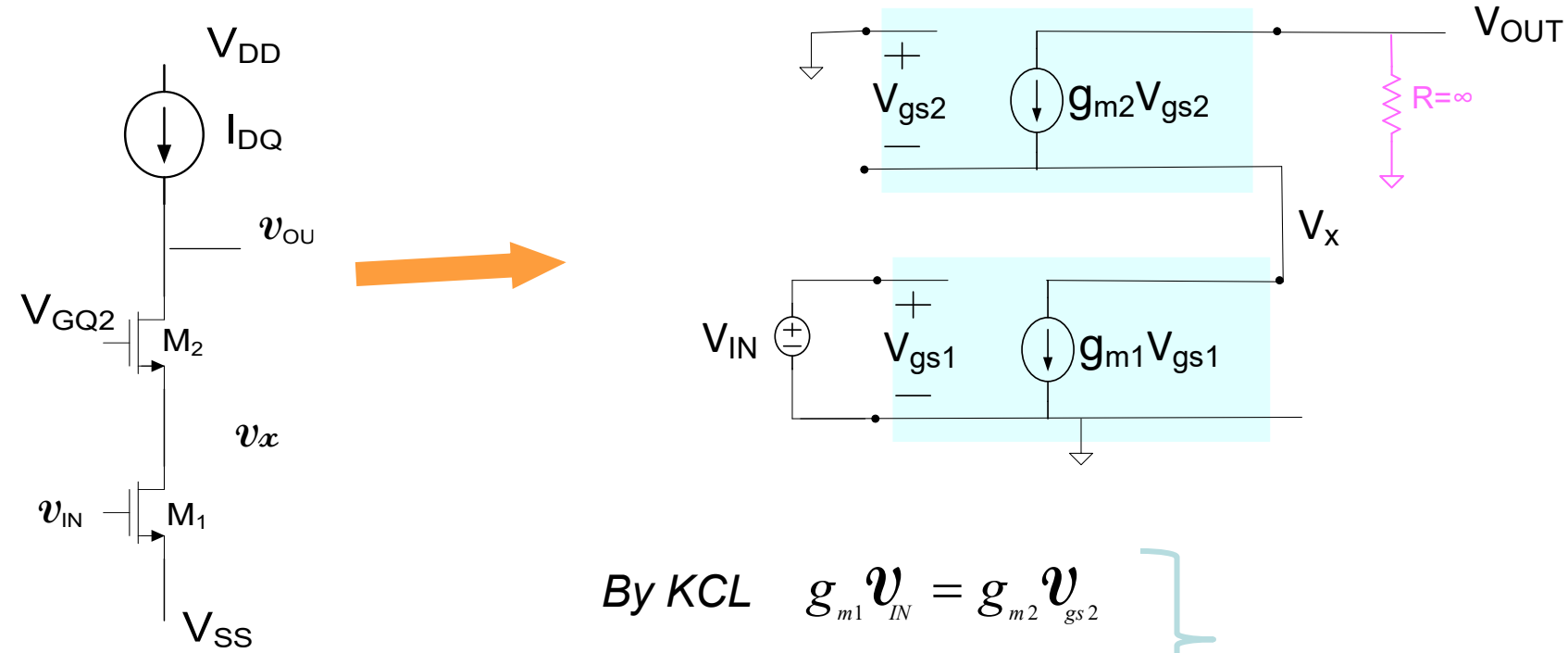

By KCL

$$\left. \begin{aligned} g_{m1} v_{IN} &= g_{m2} v_{gs2} \\ g_{m2} v_{gs2} &= -v_{OUT} \end{aligned} \right\}$$

Solving obtain:

$$A_V = \frac{v_{OUT}}{v_{IN}} = -g_{m1} R \xrightarrow{R=\infty} \infty$$

Unexpectedly large, need better device models!

Example: Determine the small signal voltage gain $A_V = v_{OUT}/v_{IN}$. Assume M_1 and M_2 are operating in the saturation region and that $\lambda \neq 0$

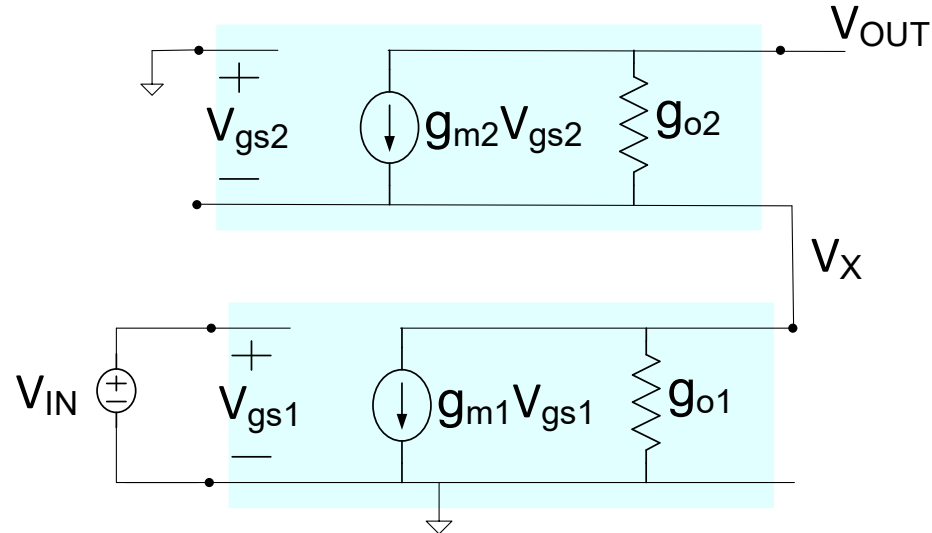
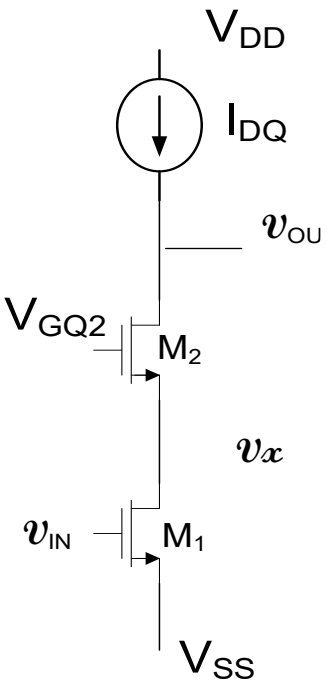

By KCL

$$\left. \begin{aligned} g_{m1} v_{IN} + g_{o1} v_X &= g_{m2} v_{GS2} + g_{o2} (v_{OUT} - v_X) \\ v_{GS2} &= -v_X \\ (v_{OUT} - v_X) g_{o2} + g_{m2} v_{GS2} &= 0 \end{aligned} \right\}$$

$$\left. \begin{aligned} g_{m1} v_{IN} + (g_{m2} + g_{o1} + g_{o2}) v_X &= g_{o2} v_{OUT} \\ v_{OUT} g_{o2} &= (g_{m2} + g_{o2}) v_X \end{aligned} \right\}$$

$$A_V = \frac{v_{OUT}}{v_{IN}} = - \frac{g_{m1} g_{m2} + g_{m1} g_{o2}}{g_{o1} g_{o2}} \cong - \frac{g_{m1} g_{m2}}{g_{o1} g_{o2}}$$

thus:

- Analysis is straightforward but a bit tedious
- A_V is very large and would go to ∞ if g_{o1} and g_{o2} were both 0
- Will look at how big this gain really is later



Stay Safe and Stay Healthy !

End of Lecture 25